

Product Information

ALUCOBOND® aluminium composite panels consist of a polyethylene core sandwiched between two sheets of aluminium.

ALUCOBOND® plus aluminium composite panels consist of a high mineral filled core (hardly inflammable) sandwiched between two sheets of aluminium.

ALUCOBOND® A2 aluminium composite panels consist of a high mineral filled core (non-combustible) sandwiched between two sheets of aluminium.

Available Sizes ALUCOBOND® / ALUCOBOND® plus

Thickness : Standard: 4 mm
For special application 3 mm, 6 mm

Width : Standard: 1000, 1250, 1500, 1575 mm

Length : To customer's specification
Range : 2000 - 8000 mm

Technical Data					
Panel-Thickness:		3mm	4mm	6mm	
Thickness of Aluminium Cover Sheets	[mm]	0.50	0.50	0.50	
Weight					
ALUCOBOND®	[kg/m ²]	4.5	5.5	7.3	
ALUCOBOND® plus	[kg/m ²]	6.0	7.6	10.8	
ALUCOBOND® A2	[kg/m ²]	6.0	7.6	-	
Technical Properties:					
Section Modulus	Z	[cm ³ /m]	1.25	1.75	2.75
Rigidity	EI	[kNcm ² /m]	1250	2400	5900
Alloy	EN-AW5005 High quality corrosion resistant				
Temperature Resistance	-50.C to +80.C				
Linear Thermal Expansion	2.4 mm/m at 100.C C temperature difference				

Acoustical Properties:					
Sound Absorption Factor	α_s		0.05	0.05	0.05
Airborne Sound Insulation Index	R_w	[dB]	25	26	27
Loss Factor	d		0.0072	0.0087	0.0138
Thermal Properties:					
Thermal Resistance	1/L = R	[m ² K/W]	0.0069	0.0103	0.0172
Heat Transition Coefficient	U-value	[W/m ² K]	5.65	5.54	5.34

Surfaces

ALUCOBOND® surfaces are coated using exclusively high-quality and ecofriendly coatingsystems. They are highly weather resistant and resistant to industrial emissions. These properties are achieved using UV-resistant bonding agents. For standard finishes, fluoropolymeric top coats (e.g. PVDF) are used.

The painted finishes of ALUCOBOND® are obtained in a continuous coilcoating process on a most modern paint line
- surface pre-treatment by chromating
- cover layers (double-coat /triple-coat) including primer

The stoving of the paints at temperatures from 240°C to 270°C ensures excellent durability of these surface finishes.

The whole process including a thorough quality control of the paint finishes is carried out in accordance with E.C.C.A. (European Coil-coating Association) Standards.

For exterior application, ALUCOBOND® is available in many specially selected standard colours in (PVDF) fluorocarbon lacquer coating. For details, refer to the ALUCOBOND® World of Colours brochure. Custom colours are available on request.

Protective Peel-off-foil

The finished surface is factory protected with a self-adhesive peel-off- foil, tested to withstand at least 6 months exposure to local weather condition without losing the original peel-off characteristic or causing stains or other damages.

Flatness

With a standard gloss of approx. 30-40% acc. to Gardner Scale, the panel surface taken individually shall not have any irregularities such as oil canning, waves, buckles and other imperfections when viewed from any position but not less than at an angle of 15 degrees to the true plane of the panel, with natural lighting of incident of not less than the same angle.



World of Colours



Spectra & Sparkling Colours

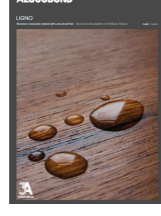
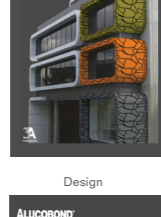
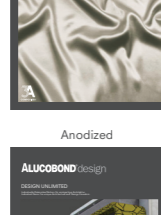
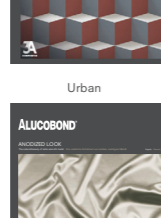
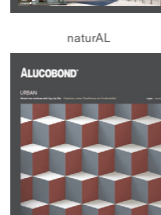
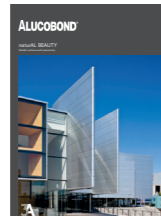

Specialty Finishes

Your vision materialized.

ALUCOBOND

ALUCOBOND (FAR EAST) PTE LTD
6 Shenton Way #40-05
OUE Downtown 1
Singapore 068809
Tel: (65) 6303 9750
Fax: (65) 6303 9751
Email: sales@alucobond.com.sg
www.alucobond.com.sg

3A COMPOSITES INDIA PVT. LTD.
Unit 852, 5th Floor,
Solitaire Corporate Park,
Andheri-Kurla Road,
Andheri (East),
Mumbai-400 093, India
Tel: (91) 22 4265 4500
Fax: (91) 22 4265 4545
Email: info.india@alucobond.com
www.alucobond.in

3A COMPOSITES GmbH
Alusingenplatz 1
D-78224 Singen,
Germany
Tel: (49) 0 7731 941 0
Fax: (49) 0 7731 941 3510
Email: info.eu@alucobond.com
www.alucobond.com

3A COMPOSITES MIDDLE EAST (BRANCH)
Almas Tower, JLT
P.O. Box 340 505, Dubai
U.A.E
Mob: (971) 50 5574676
Email: markus.setz@3AComposites.com
www.alucobond.com

3A COMPOSITES (JIANGSU) LTD.
10 South Hehuan Road
Zhonglou, Changzhou 213023,
China
Tel: (86) 519 8166 5766
Fax: (86) 519 8166 5999
Email: info.china@alucobond.com
www.alucobond.com.cn

3A COMPOSITES USA, Inc.
3480 Taylorsville Highway,
Statesville, N.C. 28625
U.S.A
Tel: (1) 704 872-8974
Fax: (1) 704 878-2708
Email: info.usa@3ACComposites.com
www.AlucobondUSA.com

ALUCOBOND®

AT A GLANCE

All you need to know about the original aluminium composite material

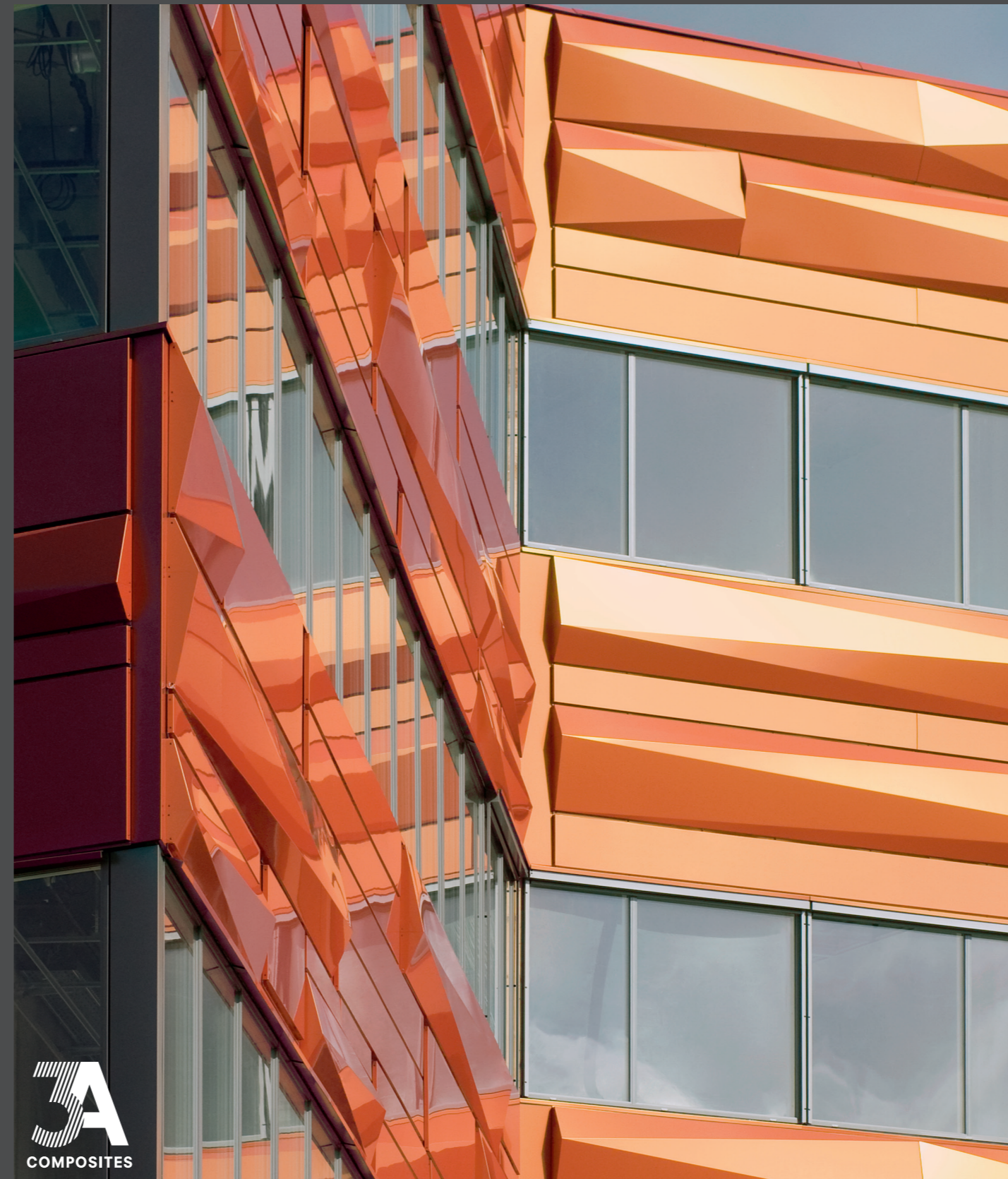

AFED004_09_11

ABOUT ALUCOBOND®

ALUCOBOND® came into existence in 1969. Since then it has not only been the most preferred brand of aluminium composite material (ACM) or panel (ACP) for architecture cladding applications, but also shaped the way buildings are looking and built worldwide.

Being the pioneer, ALUCOBOND®, has become synonymous for ACM/ACP. All this is the result of continuous efforts put into development of products, surface finishes and solutions to help architects, building owners and fabricators turn their ideas into reality and to give buildings and skylines the shape of the future.

ALUCOBOND® adapts perfectly to the buildings' contours. It can easily be cut and shaped, without having to compromise on the surface finish, compared to other ACM/ACP or metal cladding materials commonly available in the market. Whether soft curves or perfect flatness, ALUCOBOND® will provide a perfect design. The unmatched properties of this material can give shape to any project - from a private home to a corporate building, from a stadium to an airport, from a shopping mall to an institution. Be it a façade cladding or a roofing application, be it an interior column cladding or a ceiling application, can give it a distinguished look which will last forever.

ALUCOBOND® can boast of being the only truly global ACM/ACP manufacturer, having production facilities, customer service sites and distribution partners all over the world, reaching out to customers with best quality products along with seamless service at all times. The advantage of this global presence is best seen in a situation - wherein an architect or a facade consultant could be based in certain part of the world, the local consultant could be based in another, and the fabricator could be based in yet another part, ALUCOBOND® helps by joining the dots and is able to serve all the stakeholders with utmost proficiency.

Reasons to choose ALUCOBOND®:

- Marine grade Alloy that is inherently corrosion-resistant
- Right formulation and quality of mineral-filled core for non-combustible (ALUCOBOND® A2) and fire-retardant (ALUCOBOND® plus) product
- Where the product is suitable/allowed, we only use virgin LDPE for the core of the traditional, non-fire retardant product (ALUCOBOND® PE)
- The best surface coating for long-term architectural use (we only use fluoropolymers)
- Top of the line manufacturing process – all our lines are unique designs, built and developed with the experience of millions of square meters produced
- Highly experienced Technical Service support
- Unmatched warranty system backed by the leading brand in the industry
- Wide range of colors and finishes
- Class 1A Certification, meaning that our tests are done through independent 3rd parties with inspections and audits on a regular basis

And above all almost 200,000,000 square meters of history and success for more than 45 years!

ALUCOBOND® Production Sites



THE PRODUCT

ALUCOBOND®

ALUCOBOND® is a rigid, yet flexible façade material for architectural uses. ALUCOBOND® is extremely weatherproof, impact-resistant and break-proof, vibration-damping, and ensures easy and fast installation. ALUCOBOND® is produced with various core thicknesses in a continuous lamination process and then customized regarding dimensions.

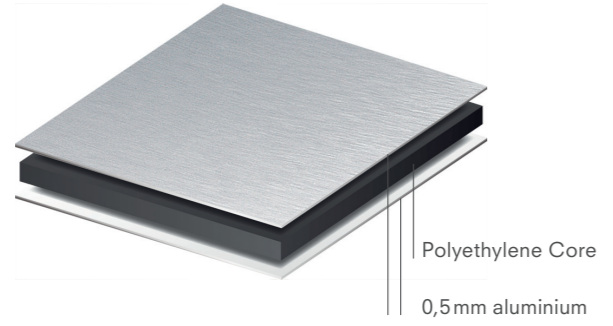

ALUCOBOND® plus

ALUCOBOND® plus has been developed exclusively for the more stringent requirements of the fire prevention regulations in architectural products. Thanks to its mineral-filled core ALUCOBOND® plus meets the stricter requirements of the fire classifications. It is hardly inflammable and offers all the proven product properties of the ALUCOBOND® family, such as flatness, formability, resistance to weather and easy processing.

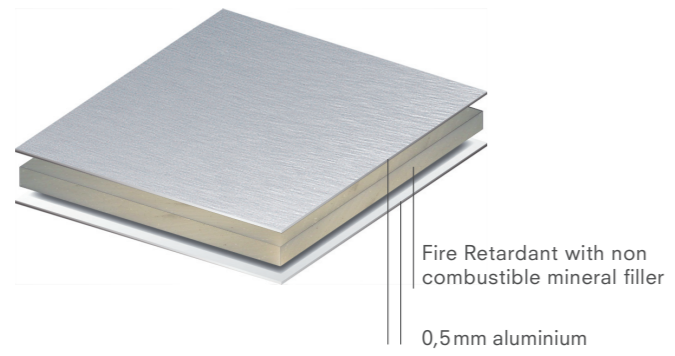

ALUCOBOND® A2

ALUCOBOND® A2 is the only non-combustible aluminium composite panel used in architecture that fulfills the respective standards worldwide. Thanks to its mineral-filled core, ALUCOBOND® A2 meets the strict requirements of the fire regulations and enhances the possibilities for the concept and design of buildings. ALUCOBOND® A2, just like all the products of the ALUCOBOND® family, allows simple processing, is impact-resistant, break-proof and weatherproof and, above all, non-combustible.

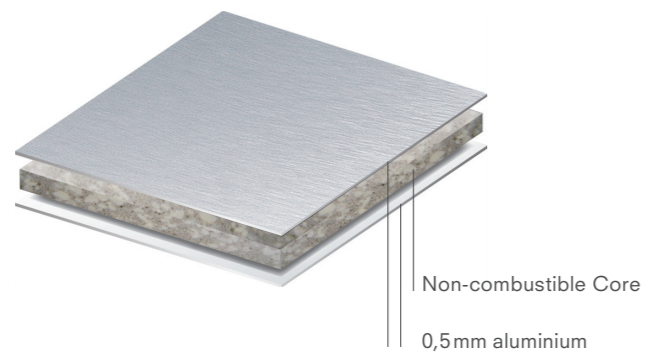

EXAMPLES OF FIXING SYSTEMS

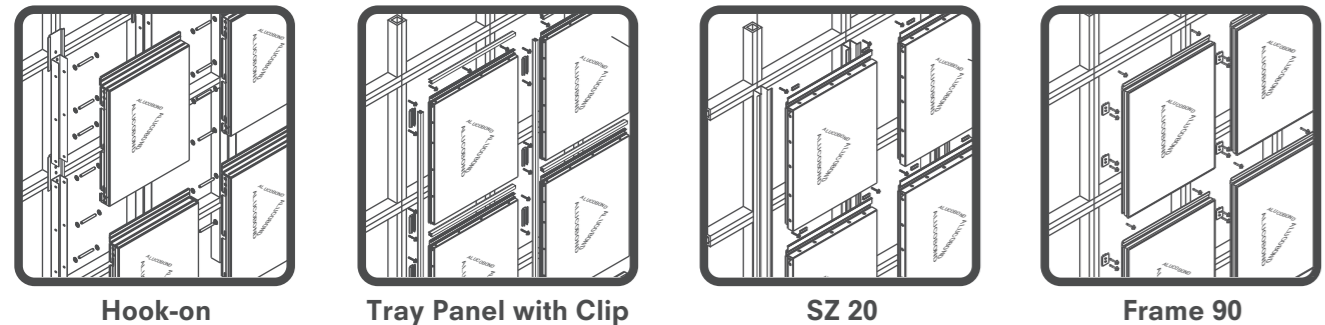

For more details in the correct application and possible limitations of these systems request for a full set of ALUCOBOND® data sheets or consult our nearest technical advisor for advice.

INDIVIDUAL DESIGN FREEDOM



USEFUL INFORMATION

ROUTING & FOLDING

Thanks to this very simple processing method ALUCOBOND® composite panels can be folded manually, following exactly the line of the routed groove. To do so grooves are routed on the reverse side of the ALUCOBOND® panel. The shape of the groove determines the bending radius. The routing can be done using a vertical panel saw equipped with ALUCOBOND® grooving accessories, a CNC machining centre, a portable sheet milling machine or a hand router. The routing and folding method can be used for ALUCOBOND® composite panels with all available standard surface finishes.

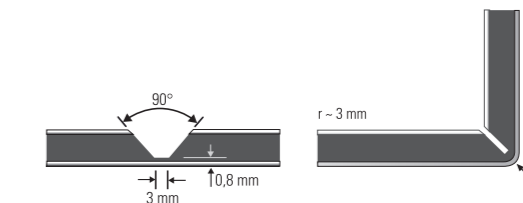

90° V-groove for folds up to 90°

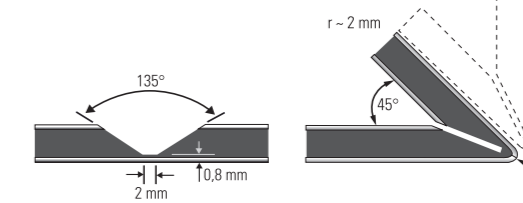

135° V-groove for folds up to 135°

INSTALLATION

To avoid possible reflection differences (for metallic, special effect, naturAL and spectra colours), it is recommended to install the panels in the same direction as marked on the protective peel-off-foil. Colour variations may occur between panels originating from different production batches. To ensure colour consistency, the total requirement for a project should be placed in one order. Make sure to remove the protective foil as soon as possible after installation as prolonged exposure to the elements could make the foil difficult to remove.

CLEANING AND MAINTENANCE

The frequency of cleaning and the choice of a suitable cleaning agent depends largely on the location of the building and the condition of the panel surface. The cleaning can be carried out with water and sponge or a soft brush. In case of more severe soiling add a neutral detergent.

STORAGE

ALUCOBOND® should be stored on pallets or shelves. The stacking height should not exceed 2m (6 pallets). Ensure dry storage.

ENVIRONMENT, HEALTH AND SAFETY

For 3A Composites, effective, continuous environmental protection is a main priority. It is of utmost importance to preserve natural resources in order to ensure a livable tomorrow for future generations. It commits itself to continuous self-improvement programmes for environmental protection, many of which go above and beyond government regulations. It is also in this area that 3A Composites strives to be a leader in its field. We were one of the first companies to develop its own environmental management system, which is regularly audited by independent auditors. The successful certification according to EN ISO 14001 speaks for itself.

RECYCLING

ALUCOBOND® can be fully recycled, i.e. both the core material and the aluminium cover sheets can be recycled and used for the production of new material.

SUSTAINABILITY

The certification system of DGNB, the German Association for sustainable construction, sets international construction standards. This is mainly due to a group of initiators who has already been dealing with questions in the context of sustainable construction. 3A Composites is one of the founding members: (www.dngb.de) The info leaflet about the DGNB certificate can be downloaded at www.alucobond.com.

WARRANTY

ALUCOBOND® stands for high quality and longevity. Warranties according to the product specification and approved field of application can be obtained upon request.

